



ET16

Tracked Conventional Tail Excavators



The most spacious and yet compact of the 1.5t class

Compact in size and yet the best of its class in terms of cabin size. The ET16 achieves not only top scores in terms of cabin comfort but also when it comes to speed. The 2nd travel speed of 4 km/h enables the ET16 to change positions quickly. Due to its very compact size and a transport weight of about 1.4t, the ET16 can be transported easily on a car trailer.

- Powerful and fuel-efficient 3-cylinder diesel engine from Yanmar.
- Direct access to the engine compartment: all service-relevant parts are directly and easily accessible.
- The largest cab in its class, ergonomically designed, high quality and modern equipped and optimum all-round visibility.
- Movable side elements of the dozer blade are fixed to the blade. No installation or tools necessary.
- Standard auxiliary hydraulics for easy operation of various attachment tools.

Quick on the spot with 4 km/h

- 2nd travel speed as standard equipment
- Saves time in daily work – change of positions with 4 km/h.





The comfort cab

- Maximum freedom of movement due to extra-large legroom.
- Ergonomically designed armrests and seat position.
- High quality finishing.
- Optimum visibility of the working areas.
- Two-part windshield
- Comfortable seat and cabin heating for even longer working hours without physical restrictions.
- Windshield washer for keeping the perfect overview at all times.

Car trailer transport

- Due to its compact size and a transport weight of below 1.7 tons, the ET16 can be transported on a car trailer.

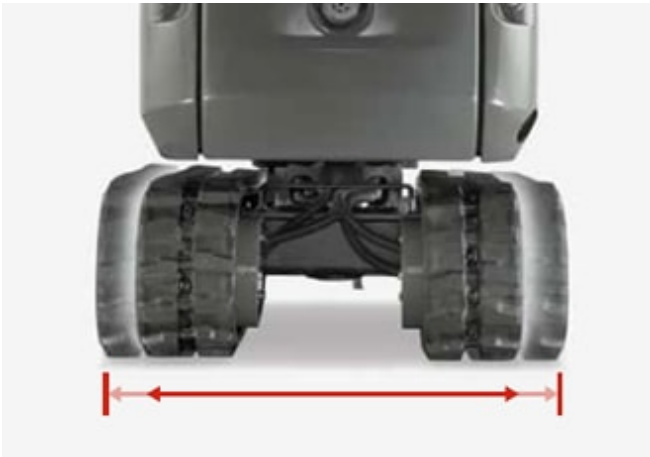

Extendable telescopic undercarriage

- Optionally adjustable width of the undercarriage from 990 to 1300 mm.
- Manages narrow passages with no problems and has so easy access to even hardly accessible job sites.



Technical specifications

Operating data

Shipping weight min.	1,402 kg
Operating weight	1,529 - 1,720 kg
Biting force max.	7.9 kN
Breakout force max.	15.3 kN
Digging depth max.	2,413 mm
Dumping height	2371 - 2518 mm
Digging radius max.	3,861 mm
Superstructure slewing speed	9.8 1/min
L x W x H	3644 x 990 x 2285 mm

Engine / Motor

Engine / Motor manufacturer	Yanmar
Engine / Motor type	3TNV76
Engine / Motor	Water-cooled 3-cylinder diesel engine
Displacement	1,116 cm ³
RPM / speed	2,200 rpm
Engine performance acc. to ISO	13.2 kW
Battery	44 Ah
Fuel tank capacity	24 l

Hydraulic system

Duty pump	Gear pump
Flow rate	33.3 l/min
Operating pressure for working and traction hydraulics	200 bar
Operating pressure Slewing gear	130 bar
Hydraulic oil tank	20 l

Undercarriage

Travel speed	4.1 km/h
Chain width	230 mm
Ground clearance	180 mm

Dozer Blade

Width (folded in)	990 mm
Height	215 mm
Stroke max., above ground	235 mm
Stroke max., below ground	270 mm



**WACKER
NEUSON**
all it takes!

Sound level

Sound level (LwA) acc. to 2000/14/EC	93 dB(A)
Cabin - specified sound pressure level LpA	79 dB(A)



Dimensions

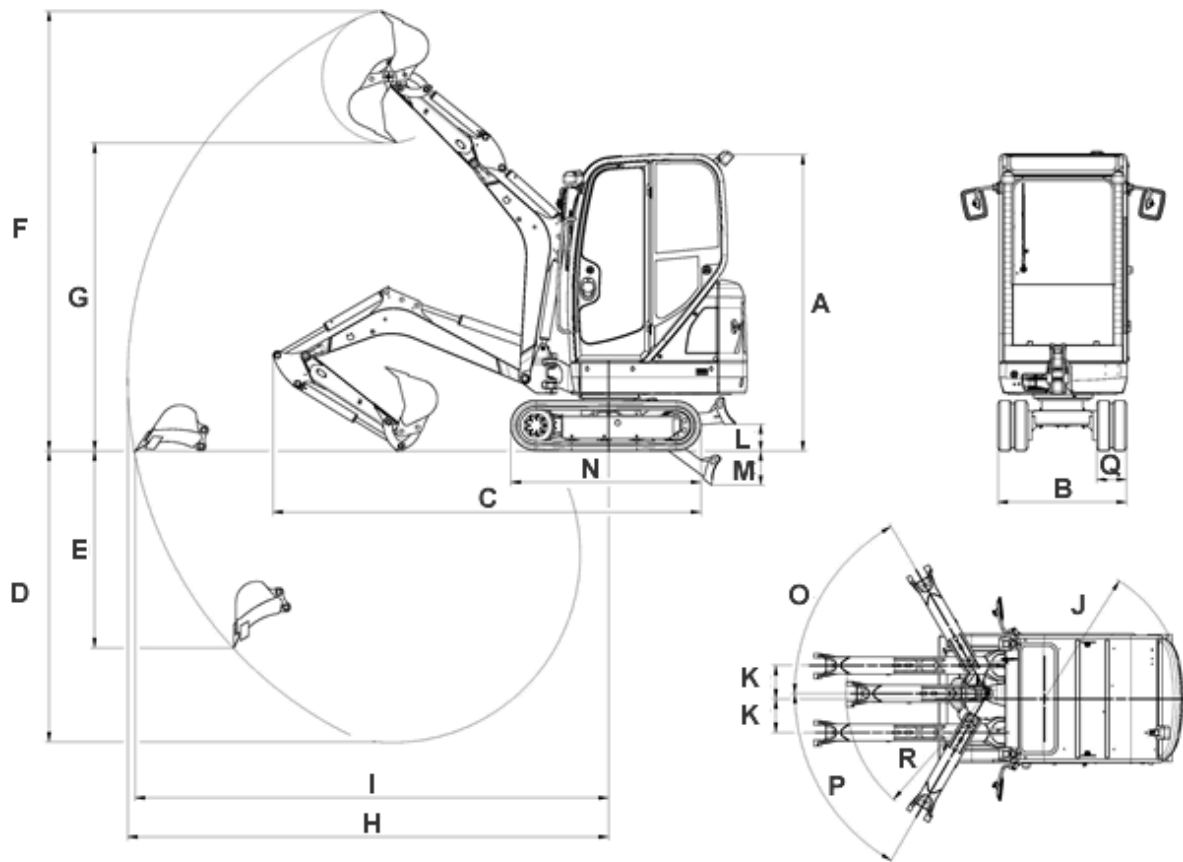

A	Height	2,285 mm	2,317 mm
B	Width undercarriage	990 mm	990 mm
B	Width telescopic undercarriage extended		1,300 mm
C	Transport length (bucket arm short)	3,644 mm	3,648 mm
C	Transport length (bucket arm long)	3,607 mm	3,606 mm
D	Digging depth max. (bucket arm short)	2,242 mm	2,202 mm
D	Digging depth max. (bucket arm long)	2,413 mm	2,372 mm
E	Insertion depth vertical (bucket arm short)	1,642 mm	1,605 mm
E	Insertion depth vertical (bucket arm long)	1,802 mm	1,764 mm
F	Insertion height (bucket arm short)	3,387 mm	3,408 mm



F	Insertion height (bucket arm long)	3,508 mm	3,529 mm
G	Dump height max. (bucket arm short)	2,371 mm	2,396 mm
G	Dump height max. (bucket arm long)	2,493 mm	2,518 mm
H	Digging radius max. (bucket arm short)	3,700 mm	3,700 mm
H	Digging radius max. (bucket arm long)	3,861 mm	3,860 mm
I	Range (bucket arm short)	3,648 mm	3,642 mm
I	Range (bucket arm long)	3,811 mm	3,806 mm
J	Rear swivel radius	1,075 mm	1,075 mm
K	Arm displacement max. boom offset to centre of bucket right side	432 mm	432 mm
K	Arm displacement max. boom offset to centre of bucket left side	287 mm	287 mm
L	Lift height max., of dozer blade above ground	211 mm	235 mm
M	Scraping depth max., of dozer blade below ground	264 mm	270 mm
N	Length total crawler length	1,462 mm	1,462 mm
O	Turning angle max., of boom system to the right	49 °	49 °
P	Turning angle max., of boom system to the left	73 °	73 °
Q	Chain width	230 mm	230 mm
R	Boom slewing radius	1,195 mm	1,195 mm

Please note

that product availability can vary from country to country. It is possible that information / products may not be available in your country. More detailed information on engine power can be found in the operator's manual; the stated power may vary due to specific operating conditions.

Subject to alterations and errors excepted. Applicable also to illustrations.

Copyright © 2017 Wacker Neuson SE.